

BBQ RANGEHOOD



FEATURES

#316 MARINE GRADE
STAINLESS STEEL

REMOTE CONTROL

TOUCH CONTROL
PANEL WITH DIGITAL
DISPLAY, 24 HR CLOCK
& DELAY OFF TIMER

DISHWASHER SAFE
#304 STAINLESS STEEL
REMOVABLE BAFFLE
FILTERS

2 YEAR WARRANTY

DISTRIBUTED BY GBI SALES PTY LTD
78 MALLARD WAY, CANNINGTON WA 6107
PHONE | 1300 710 860
EMAIL | SALES@GBI.COM.AU

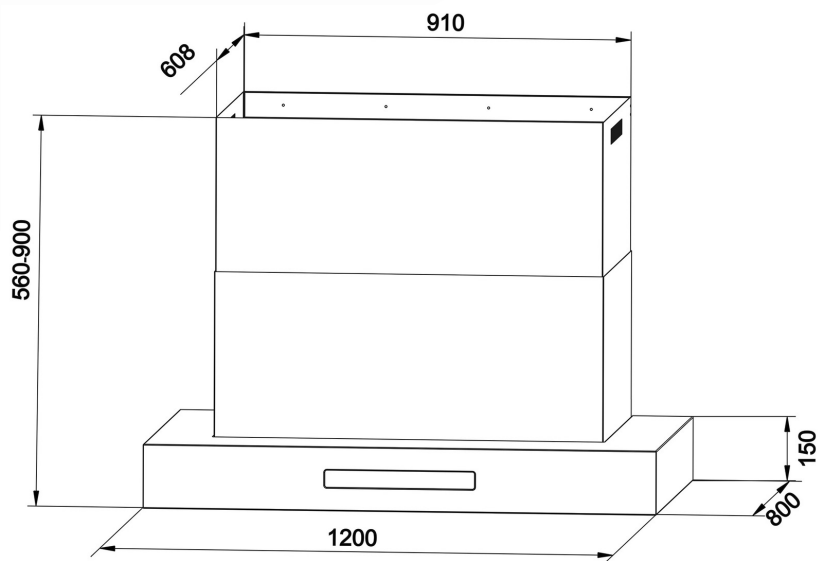

SPECIFICATIONS

- ◆ 1200 x 800mm WALL MOUNTED RANGE HOOD
- ◆ 2 x 238 WATT DOUBLE CHAMBER ULTRA QUIET MOTORS WITH 3 SPEED SETTINGS
- ◆ 2600 M3/HR EXTRACTION CAPACITY (GROSS)
- ◆ NOISE LEVEL 25- 35 dB (LOW-HIGH) PER MOTOR
- ◆ 4 x 1.5 WATT SUPER BRIGHT LED LIGHTS
- ◆ 2 x 150mm DIAMETER SEMI RIGID DUCTING